

BULLETIN 51B

PARTS
TELETYPESETTER OPERATING UNIT
TOU8 AND TOU9

TELETYPESETTER CORPORATION

CHICAGO, ILLINOIS

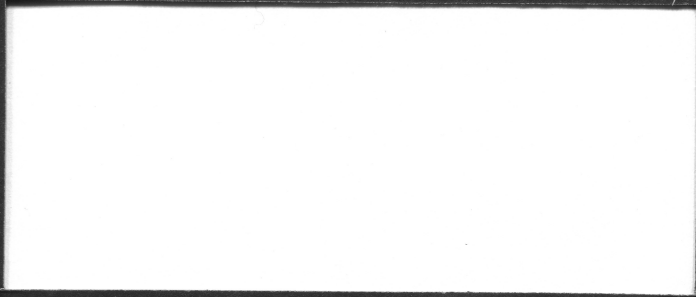

TELETYPESETTER CORPORATION

CHICAGO, ILLINOIS

TELETYPESETTER

BULLETIN 51B

PARTS

TELETYPESETTER OPERATING UNIT

TOU8 AND TOU9

TELETYPESETTER

CORPORATION

1400 WRIGHTWOOD AVE.,

CHICAGO, U.S.A.

Copyright 1952 by Teletypesetter Corporation in the United States. Copyright in all countries participating in International Convention and Pan American Conventions. All rights reserved including rights of translations into all languages.

Printed in U. S. A.

Printed in U.S.A.

TELETYPESETTER

BULLETIN 518

PARTS

TELETYPESETTER OPERATING UNIT

1005 AND 1009

TELETYPESETTER

-A-
(51B)

LIST OF EFFECTIVE PAGES
JANUARY, 1952

PAGE NUMBERS	CHANGE IN EFFECT	PAGE NUMBERS	CHANGE IN EFFECT
A to B 1 to 14	Original Original		

The above list indicates the effective pages as of the date of issue. When a change takes place in any of the following pages this page likewise changes.

ORIGINAL

ALPHABETICAL INDEX

	<u>Page</u>
Base	1
Bell Cranks and Bearing	1,2
Bottom Cover Plate	8
Code Bars	1,8
Code Bar Extensions	5,8
Code Bar Extension Guides	5
Covers	8
Delay Mechanism	6
Elevator Clutch Shaft	3
Elevator Clutch Shaft Bearing	4
Elevator Clutch Trip Mechanism	2
Elevator Latch and Bracket	4
Extension Shaft	1
Hanger	1,2
Manual Reset Cam and Detent	3
Mechanical Tape Stop Mechanism	10,11
Numerical Index	13,14
Pulley Shaft	1
Push Bar Levers	6
Push Bar Mechanism	1,2
Selecting Mechanism	7
Selector Clutch Shaft	3
Selector Clutch Shaft Bearing	4
Shift Mechanism	7
Tape Feed Mechanism	6
Tape Feed Stop Bail	5
Tape Reel	8
Tape Reel Bracket	8
Tools	9
Top Plate	5
Transfer Bail and Levers	6

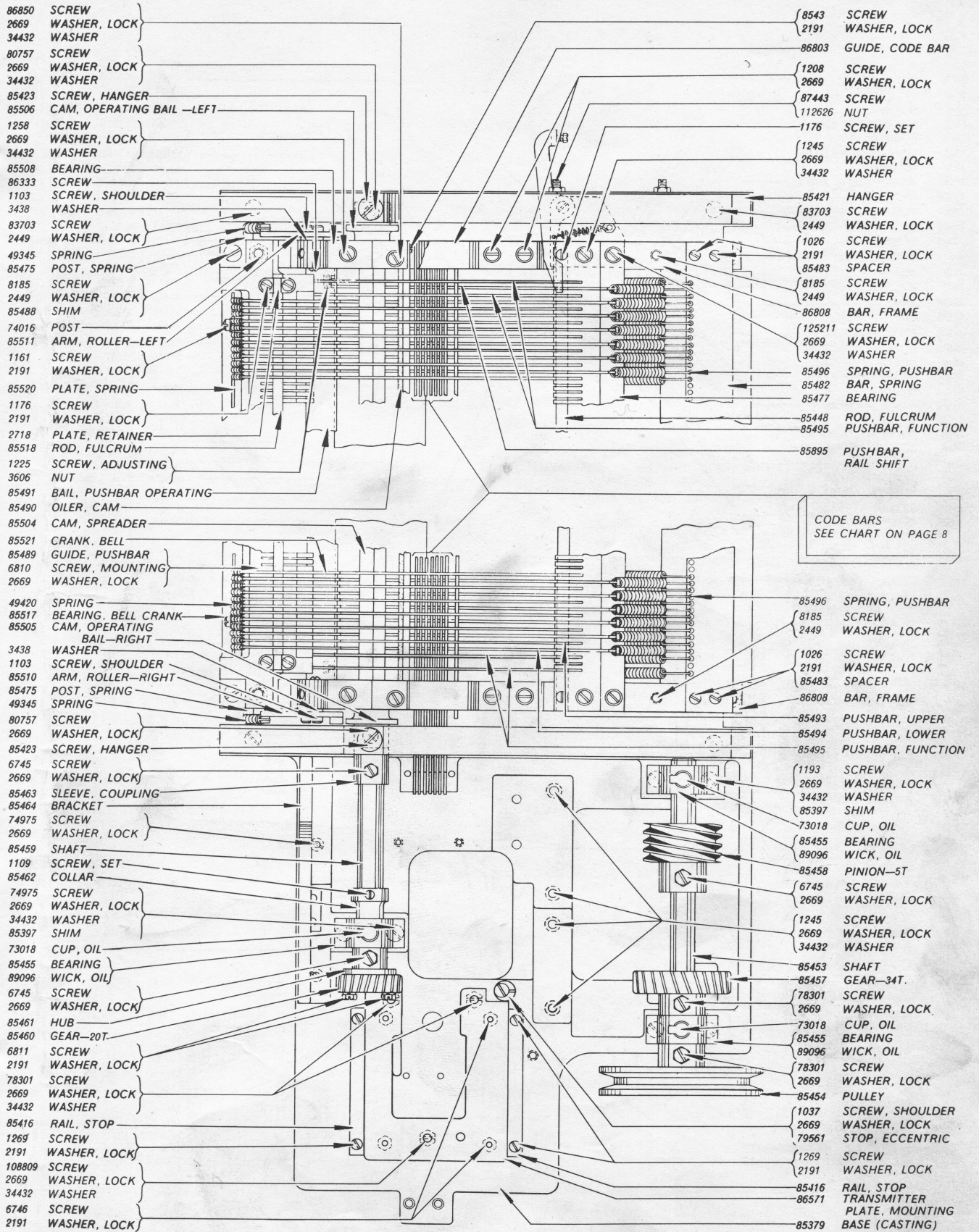

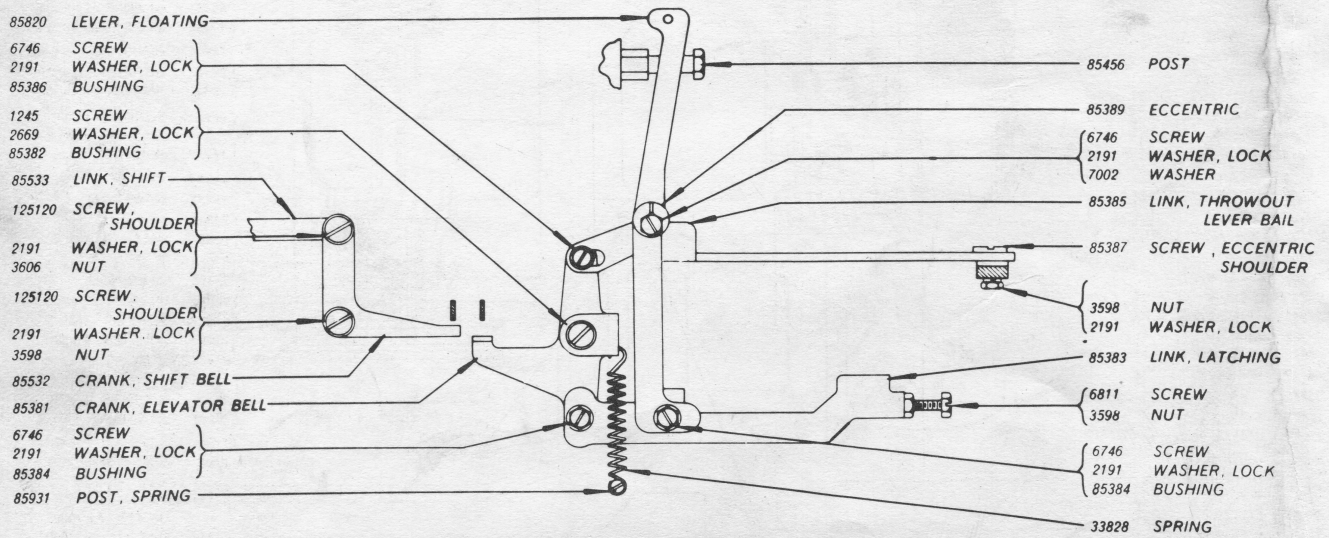
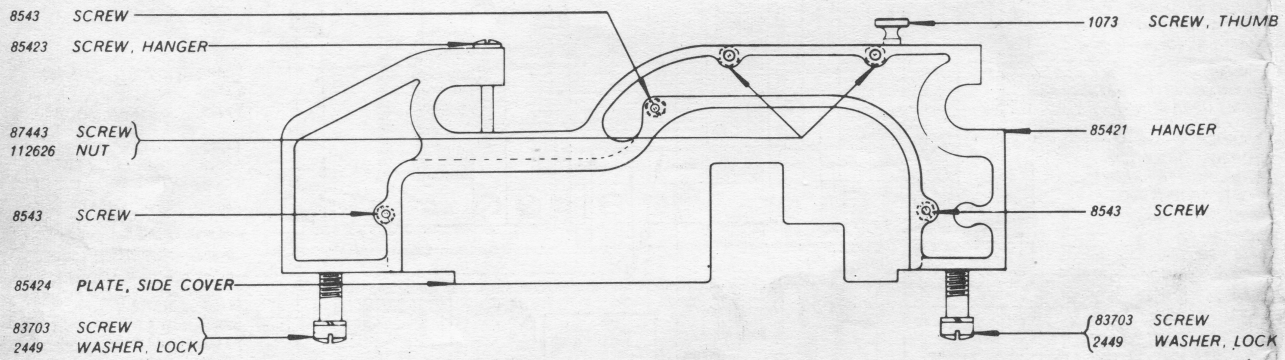
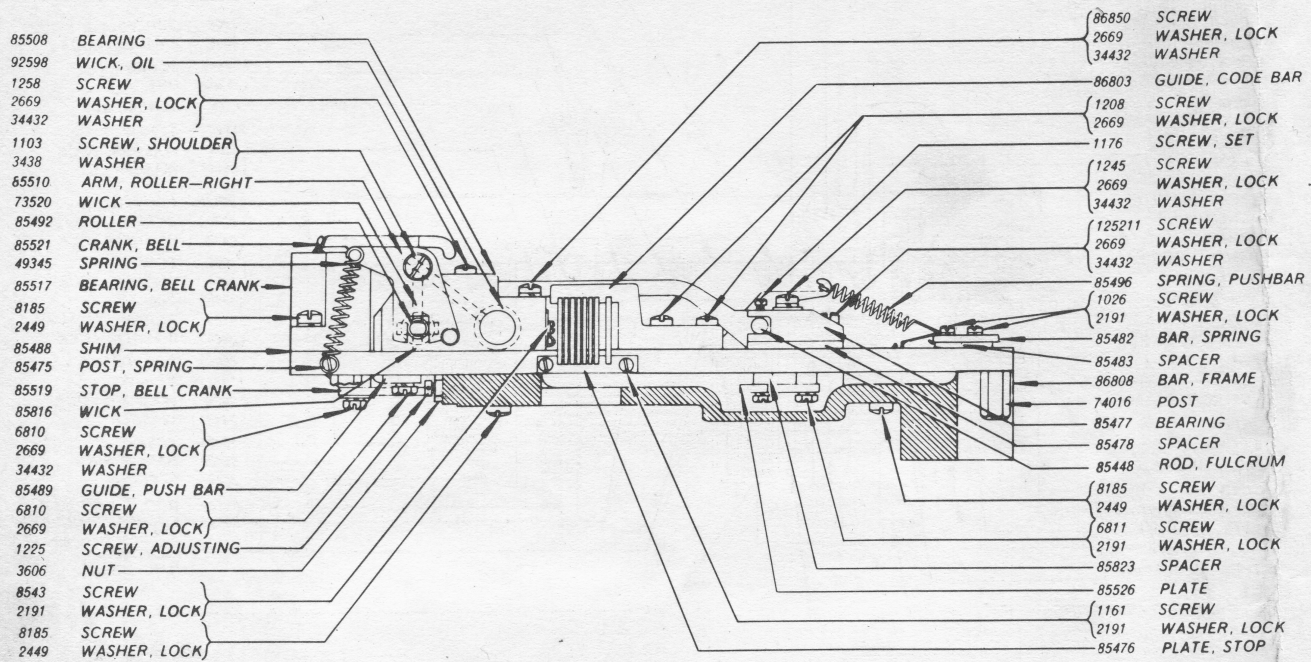

ORIGINAL

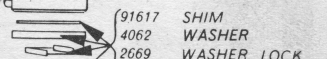
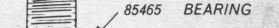
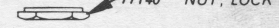
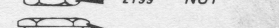
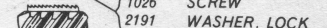
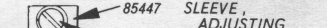
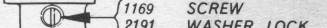
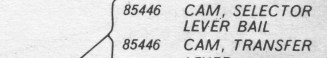
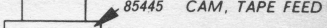
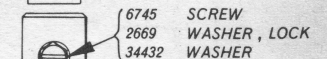
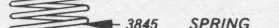
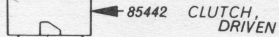
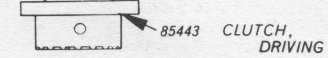
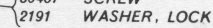
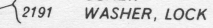
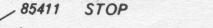
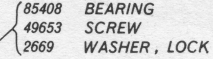
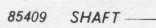
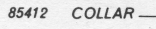
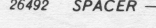
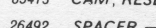
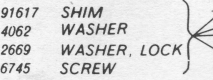
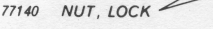
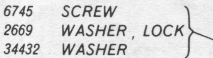
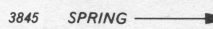
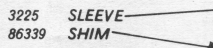
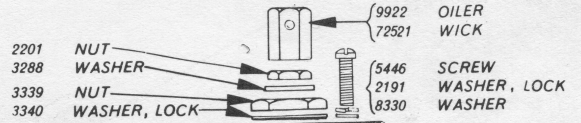
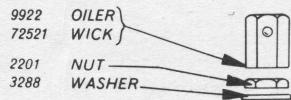

ELEVATOR CLUTCH SHAFT

SELECTOR CLUTCH SHAFT

ORIGINAL

6746 SCREW
2191 WASHER, LOCK
85393 BUSHING

85391 PLATE, CLAMP

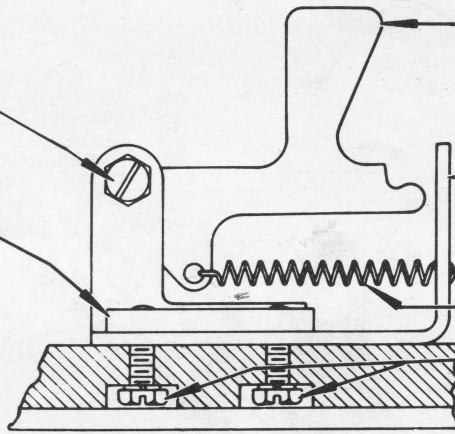

85392 LATCH

85390 BRACKET, LATCH

41974 SPRING

6811 SCREW
2191 WASHER, LOCK

80478 POST, SPRING

85432 LATCH,
CLUTCH THROWOUT LEVER

74399 SCREW, POST
2191 WASHER, LOCK

6811 SCREW
2191 WASHER, LOCK
3598 NUT

74962 SPRING

78044 POST, SPRING

85473 LEVER, DETENT

112625 SCREW, SHOULDER
72764 ROLLER
2191 WASHER, LOCK
3606 NUT

85471 SCREW
2669 WASHER, LOCK

85431 BEARING, (COMP.)

6811 SCREW
85437 BUSHING

85433 SHAFT

78741 SPRING
80478 POST, SPRING

3208 LEVER,
CLUTCH THROWOUT

85434 ARM, SPRING

76249 SCREW

85435 LEVER, RESET

76821 SCREW, SHOULDER
72764 ROLLER
3606 NUT

76058 POST, SPRING
125251 SPRING

125696 POST, SPRING
125252 SPRING

89896 OILER
89897 NUT
93050 WICK

ELEVATOR CLUTCH SHAFT BEARING

6814 SCREW, PILOT
2191 WASHER, LOCK

74962 SPRING

78044 POST, SPRING

85473 LEVER, DETENT

112625 SCREW, SHOULDER
72764 ROLLER
2191 WASHER, LOCK
3606 NUT

121844 BRACKET, BACKSTOP
6746 SCREW
2191 WASHER, LOCK

85440 BAIL, RELEASE

6811 SCREW
85437 BUSHING

6811 SCREW
3598 NUT
2191 WASHER, LOCK

74036 NUT
2669 WASHER, LOCK
34432 WASHER

3208 LEVER,
CLUTCH THROWOUT

85439 LEVER, RESET

85434 ARM, SPRING

76249 SCREW

76058 POST, SPRING

125251 SPRING

85471 SCREW
2669 WASHER, LOCK

85438 BEARING (COMP.)

85433 SHAFT

89896 OILER
89897 NUT
93050 WICK

SELECTOR CLUTCH SHAFT BEARING

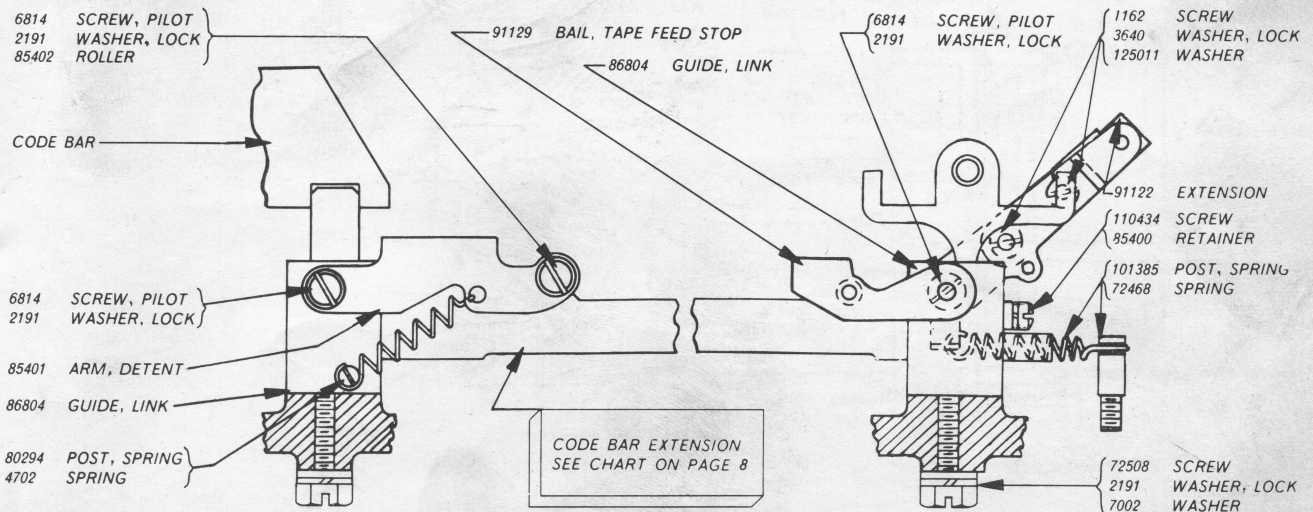
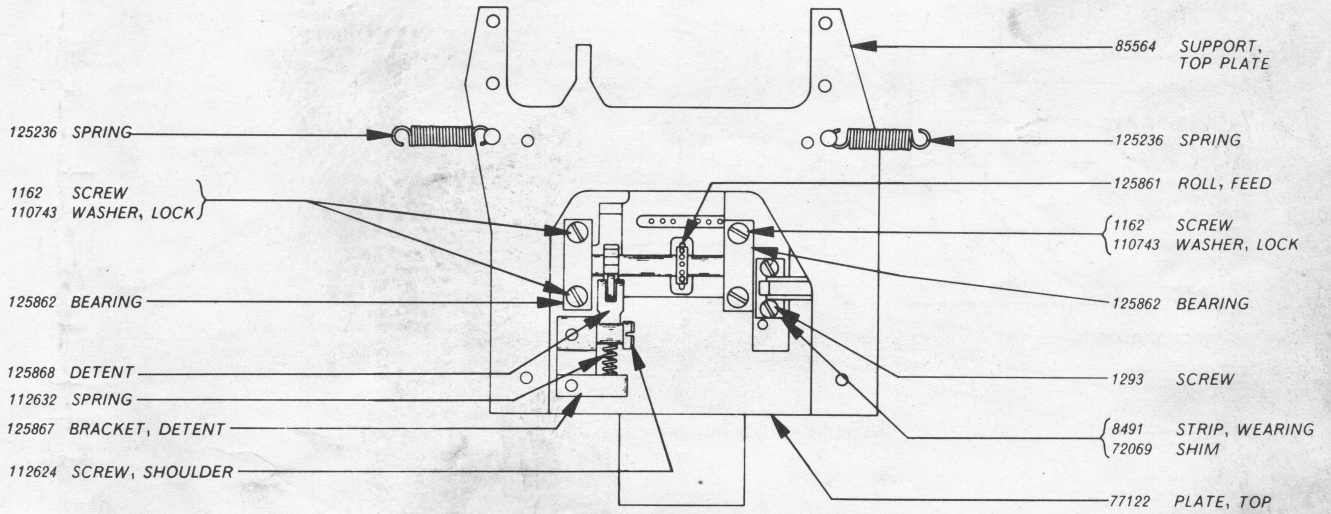
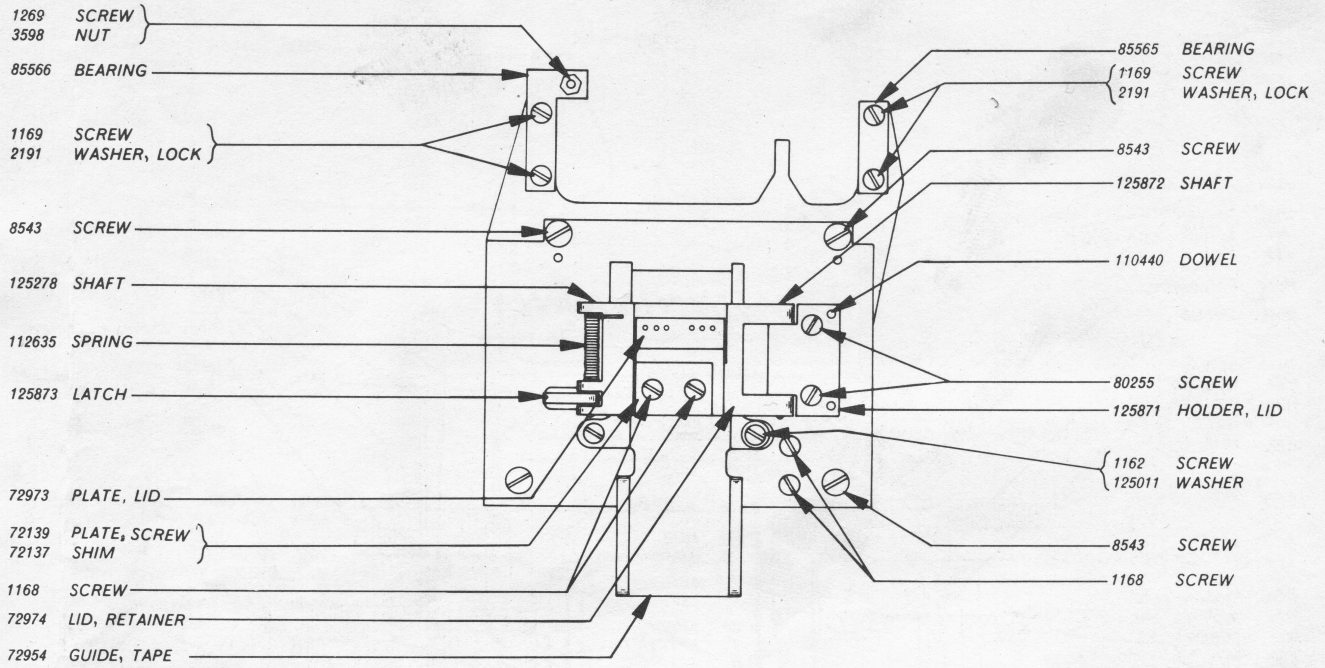

ORIGINAL

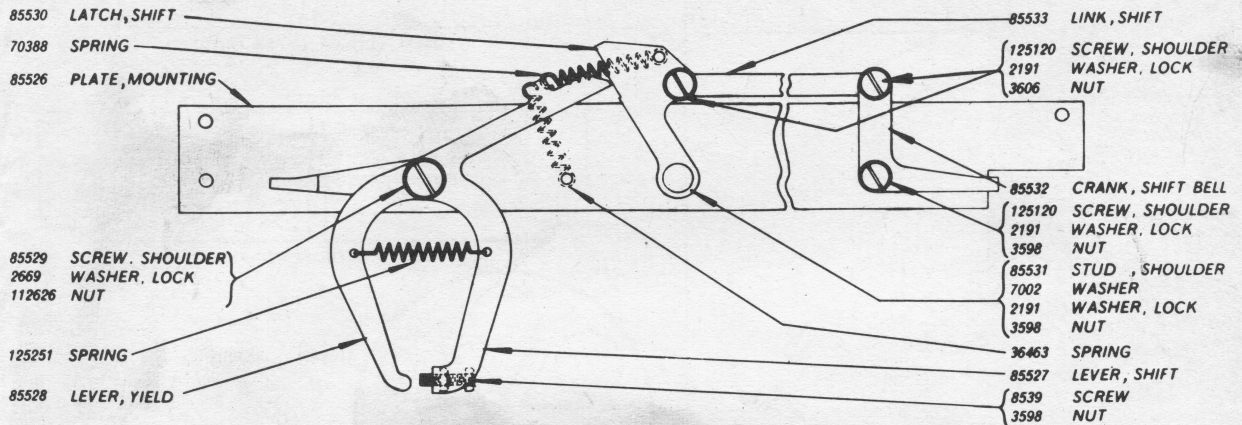

SHIFT MECHANISM

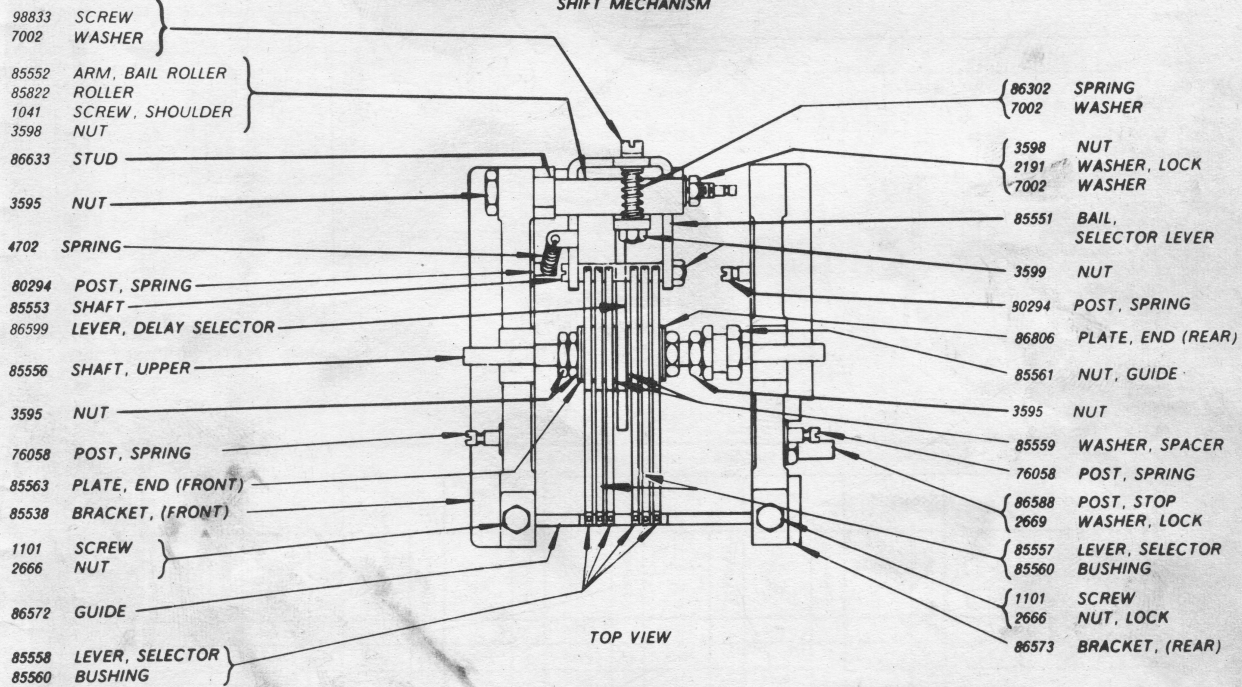

TOP VIEW

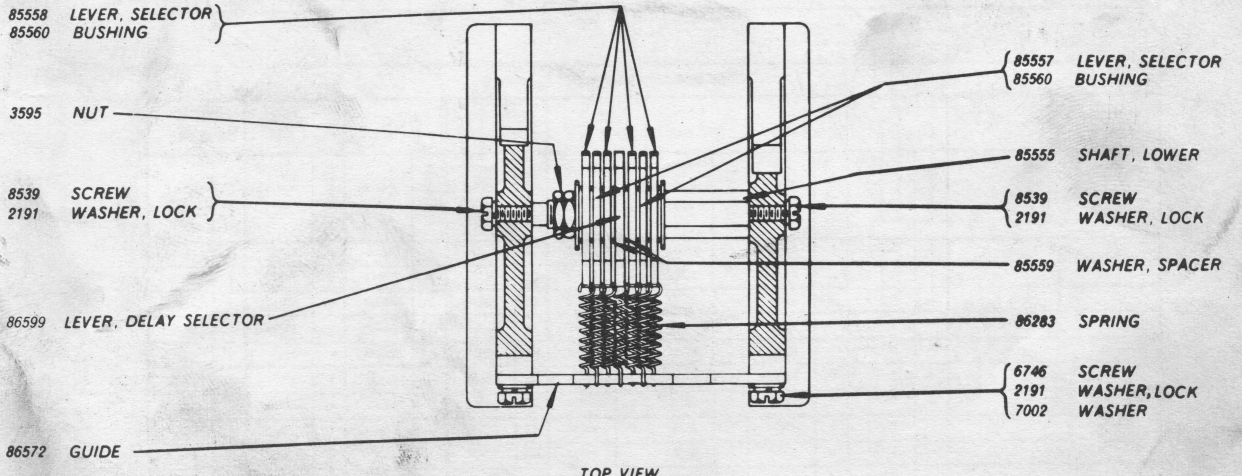

TOP VIEW

ORIGINAL

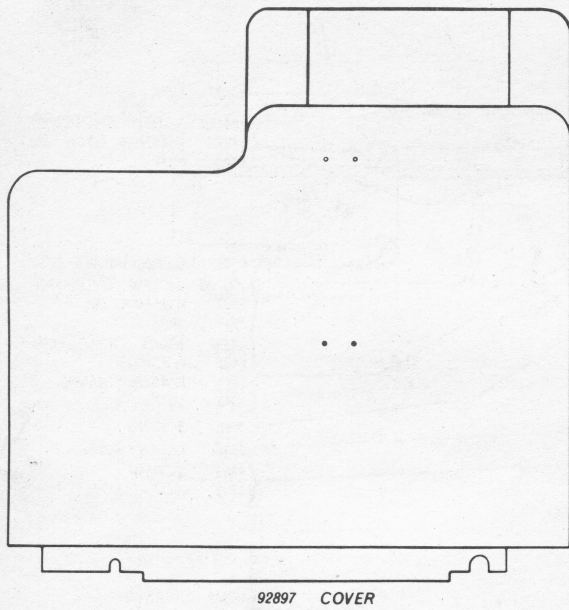

92897 COVER

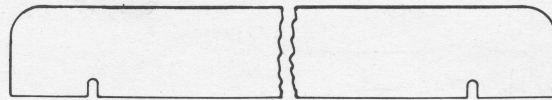

85426 COVER, UPPER FRONT

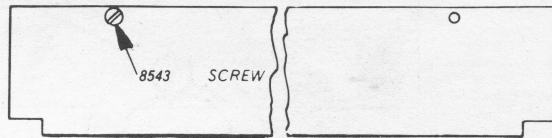

85427 COVER, LOWER FRONT

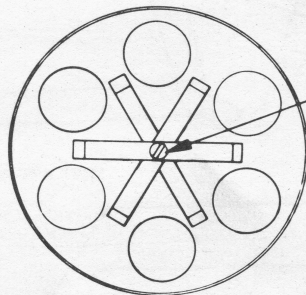

85428 REEL, TAPE

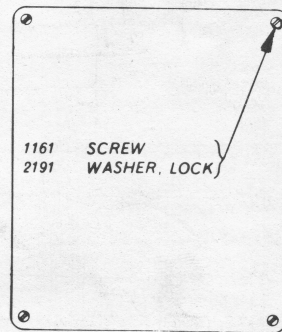

85380 PLATE, BOTTOM COVER

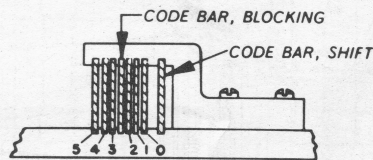
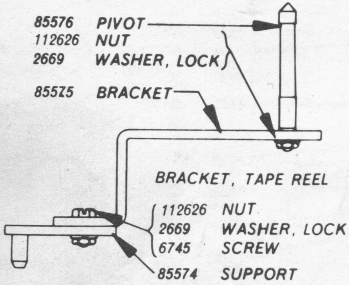

CODE BAR EXTENSION ARRANGEMENT																
LOCATION		"0"		"1"		"2"		BLOCKING BAR		"3"		"4"		"5"		
ARRANGEMENT	STAMPED	PART NO.	STAMPED	PART NO.	STAMPED	PART NO.	STAMPED	PART NO.	STAMPED	PART NO.	STAMPED	PART NO.	STAMPED	PART NO.	PART NO.	
B				85399		85399		85399			85399		85399		85399	
E			M	86600	M	86600	M	86600	M	86600	MS	86602	M	86600	S	86601
H				88075		88076		88077		88078		88079		88080		88081
M			M	86600	M	86600	MS	86602	M	86600	S	86601	M	86600	M	86600
Q			M	86600	S	86601	S	86601	M	86600	MS	86602	S	86601	S	86601

CODE BAR ARRANGEMENTS																	
LOCATION		SHIFT CODE BAR		"0" CODE BAR		"1" CODE BAR		"2" CODE BAR		BLOCKING CODE BAR		"3" CODE BAR		"4" CODE BAR		"5" CODE BAR	
ARRANGEMENT	STAMPED	PART NO.	STAMPED	PART NO.	STAMPED	PART NO.	STAMPED	PART NO.	STAMPED	PART NO.	STAMPED	PART NO.	STAMPED	PART NO.	STAMPED	PART NO.	PART NO.
A		85503	0	85497	1	85498	2	85499			3	85500	4	85501	5	85502	
D		86613	0	85497	1	86607	2	87842	BB	86603	3	87843	4	86610	5	87844	
G			0	85497	1	86607	2	86608	BB	86603	3	86609	4	86610	5	86611	
J		89443	0	89445	1	89446	2	89447			3	89448	4	89449	5	89450	
L		91137	0	85497	1	85498	2	91138	BB	86603	3	85500	4	85501	5	85502	
N		85503	0	85497	1	85498	2	85499	BB	86603	3	85500	4	85501	5	85502	
P		85503	0	93058	1	93059	2	85499	BB	93061	3	93060	4	85501	5	85502	
AB		97273	0	85497	1	85498	2	91138	BB	86603	3	85500	4	85501	5	85502	
AF		91137	0	93058	1	93059	2	91138	BB	93061	3	93060	4	85501	5	85502	
AJ		97273	0	93058	1	93059	2	91138	BB	93061	3	93060	4	85501	5	85502	

ORIGINAL

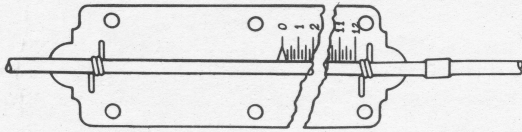

4841 SCALE, 12 LB.
82711 SCALE 64 OZ.

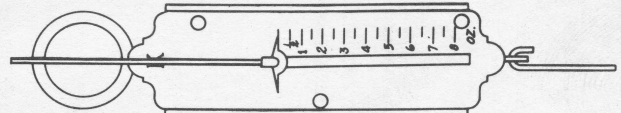

110443 SCALE, 8 OZ.

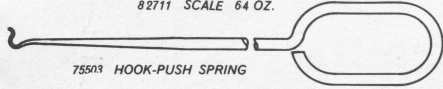

75503 HOOK-PUSH SPRING

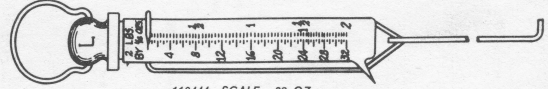

110444 SCALE, 32 OZ.

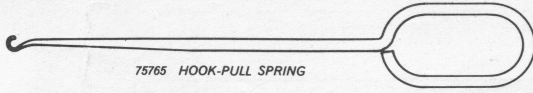

75765 HOOK-PULL SPRING

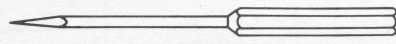

110442 DRIVER, SCREW

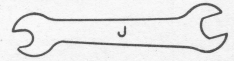

125763 3/16"-1/4" WRENCH, OPEN

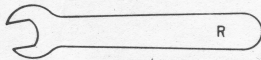

125776 5/16" WRENCH, OPEN

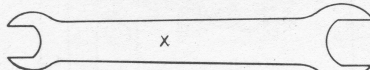

2802 3/8"-9/16" WRENCH, OPEN

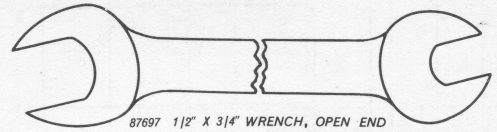

87697 1/2" X 3/4" WRENCH, OPEN END

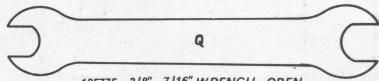

125775 3/8"-7/16" WRENCH, OPEN

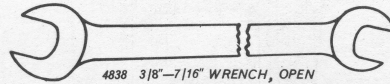

4838 3/8"-7/16" WRENCH, OPEN

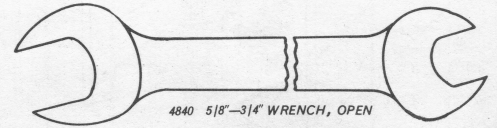

4840 5/8"-3/4" WRENCH, OPEN

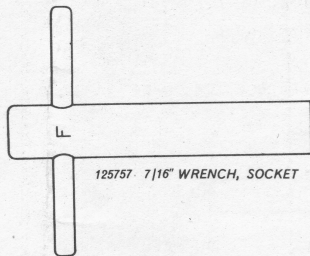

125757 7/16" WRENCH, SOCKET

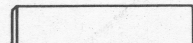

125783 STONE, CARBORUNDUM

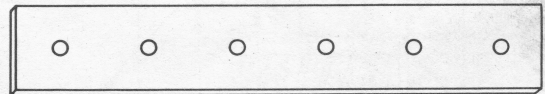

2215 GAUGE, TAPE



125752 3/16" WRENCH, SCREW DRIVER SOCKET

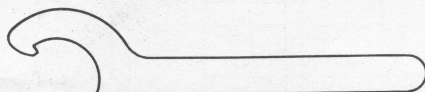

86340 WRENCH, CAPSTAN

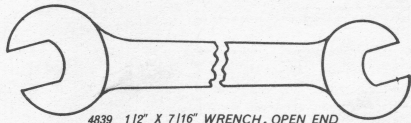

4839 1/2" X 7/16" WRENCH, OPEN END

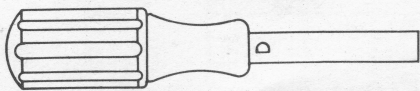

89955 5/16" WRENCH, SOCKET

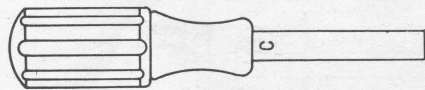

89954 1/4" WRENCH, SOCKET

- 96405-.080"
- 96403-.075"
- 96401-.070"
- 96399-.065"
- 96393-.060"
- 93827-.055"
- 96391-.050"
- 96389-.045"
- 96385-.040"
- 98136-.037"

- 96383-.035"
- 93811-.030"
- 93825-.025"
- 96377-.020"
- 93824-.018"
- 96364-.010"
- 96362-.007"
- 96360-.006"
- 93823-.005"
- 93822-.004"
- 93833-.003"
- 96358-.002"
- 96356-.002"
- 96375-.015"
- 93828-.012"
- 96373-.010"
- 96371-.008"
- 96369-.006"

117781 KIT, GAUGE

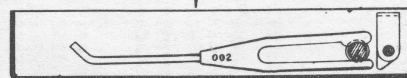

ORIGINAL

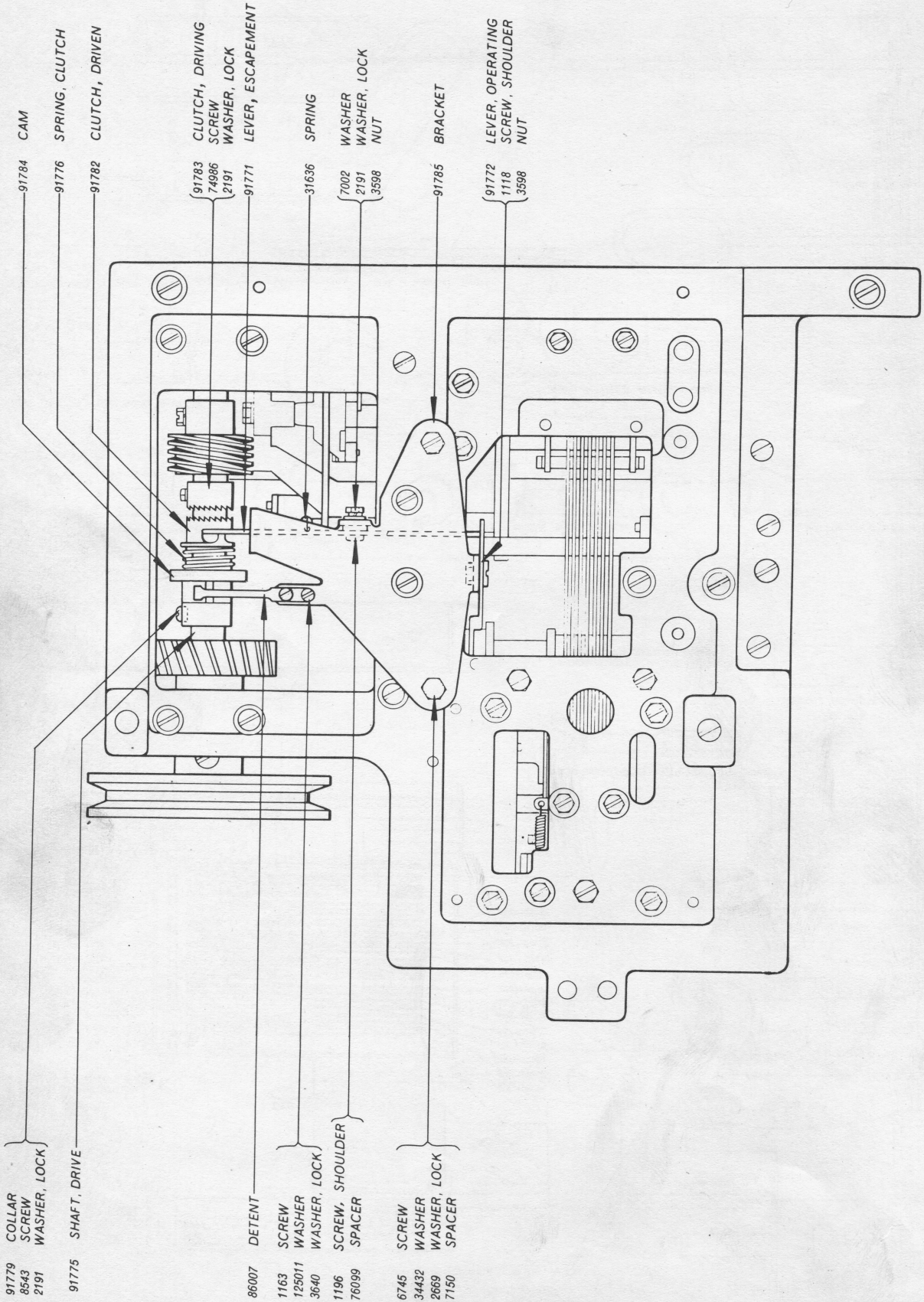

ORIGINAL

NOTE: Parts shown on this page and page 11 are peculiar to units equipped with the Mechanical Tape Stop mechanism.

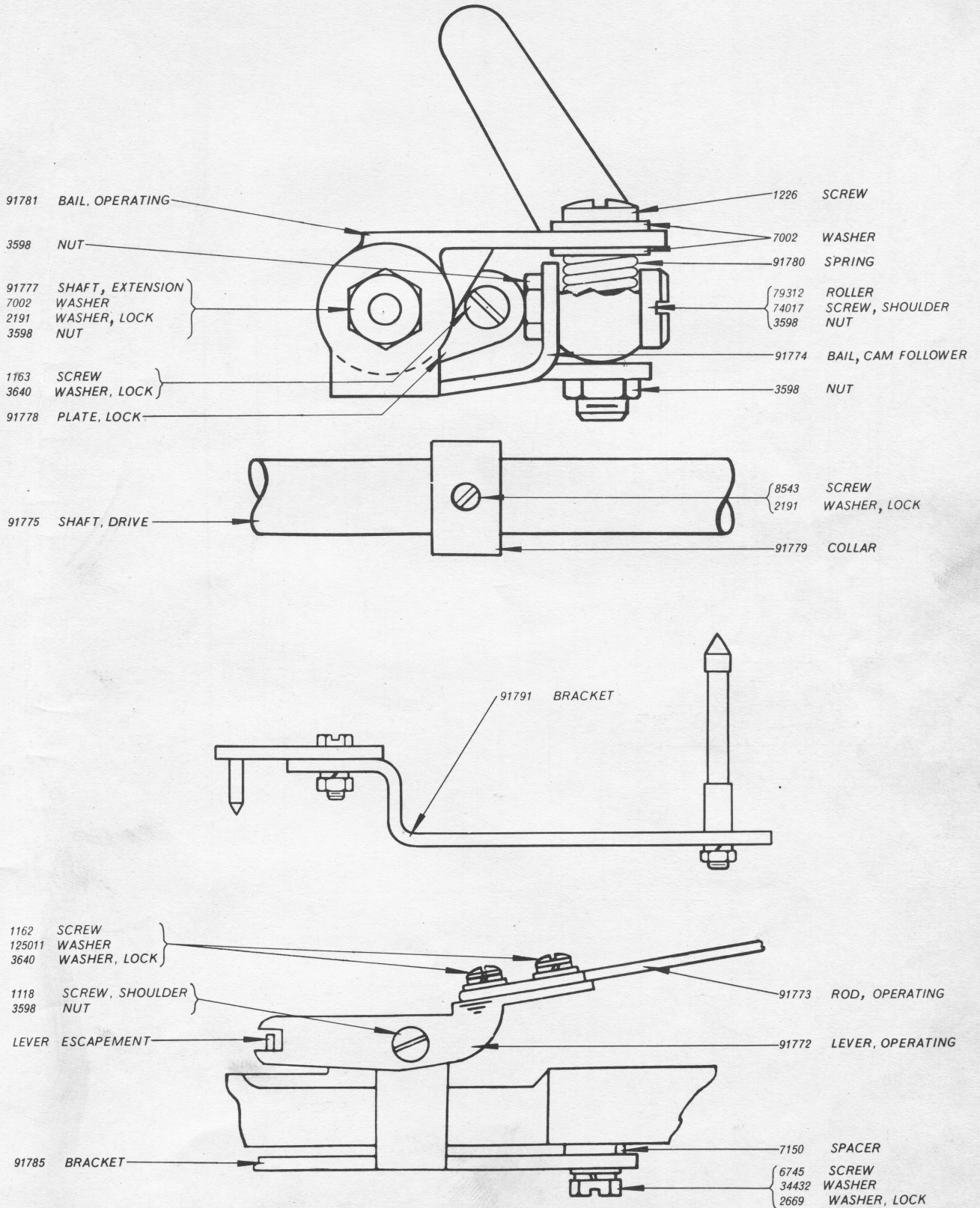

NOTE: Parts shown on this page and page 10
are peculiar to units equipped with
the Mechanical Tape Stop mechanism

ORIGINAL

-12-
(51B)

ORIGINAL

NUMERICAL INDEX

Part Number	Part	Page	Part Number	Part	Page	Part Number	Part	Page
1026	Screw (6-40 Shoulder)	1,2,3,6	73520	Wick	2	85460	Gear, 20 - T	1
1030	Screw (6-40 Shoulder)	1	74016	Post	1,2	85461	Hub	1
1037	Screw (6-40 Shoulder)	1	74017	Screw, shoulder	11	85462	Collar	1
1041	Screw (6-40 Shoulder)	6,5,7	74036	Nut (10-32 Hex.)	4	85463	Sleeve, Coupling	1
1073	Screw (6-40 Thumb)	2	74059	Screw (6-40 X 7/32)	6	85464	Bracket	1
1101	Screw (3/16-40)	7	74399	Screw (6-40 Pilot)	4	85465	Bearing	3
1103	Screw (3/16-40 Shoulder)	1,2	74708	Spring	6	85471	Screw (10-32 X 1/2)	4
1109	Screw (10-32X7/32)	1	74962	Spring	4,6	85473	Lever, Detent	4
1118	Screw (6-40 Shoulder)	11	74975	Screw (10-32 X 1/2)	1,4	85475	Post, Spring	1,2
1161	Screw (6-40 X 1/4)	1,2,8	74986	Screw (6-40 X 13/32)	6,10	85476	Plate, Stop	2
1162	Screw (4-40 X 1/4)	5,6,7,11	75765	Hook, Spring Pull	9	85477	Bearing	1,2
1163	Screw (4-40 X 3/16)	6,10,11	76037	Bushing	6	85478	Spacer	2
1168	Screw (4-40 X 5/16)	5	76038	Spacer	6	85480	Lever, Push Bar	6
1169	Screw (6-40 X 7/16)	3,5	76058	Post, Spring	4,7	85482	Bar, Spring	1,2
1176	Screw (6-40 X 3/16)	1,2	76099	Washer	10	85483	Spacer	1,2
1193	Screw (10-32 X 7/8)	1	76249	Screw (6-40 X 1/8)	4	85488	Shim	1,2
1196	Screw (Shoulder)	10	76751	Post	6	85489	Guide, Push Bar	1,2
1208	Screw (10-32 X 5/8)	1,2	76821	Screw (6-40 Shoulder)	4	85490	Oiler, Cam	1
1225	Screw, Adjusting	1,2	77122	Plate, Top	5	85491	Ball	1
1226	Screw (6-40 Shoulder)	11	77140	Nut (9/16-32)	3	85492	Roller	2
1245	Screw (10-32 X 1)	1,2	78044	Post, Spring	4	85493	Bar, Upper Push	1
1258	Screw (10-32 X 1-1/4)	1,2	78301	Screw (10-32 X 5/8)	1	85494	Bar, Lower Push	1
1269	Screw (6-40 X 1/2)	1,2,5	78741	Spring	4	85495	Pushbar, Function	1
1293	Screw (4-40 X 1/8)	1,5	79312	Roller	11	85496	Spring, Push Bar	1,2
2191	Washer, Lock	1 to 11	79561	Stop, Eccentric	1	85497	Code Bar	8
2199	Nut (7/16-32 Hex.)	3	80255	Screw	5	85498	Code Bar	8
2201	Nut (5/16-32 Hex.)	3	80294	Post, Spring	5,6,7	85499	Code Bar	8
2449	Washer, Lock	1,2	80342	Screw (6-40 X 23/64)	6	85500	Code Bar	8
2666	Nut, Lock (3/16-40)	7	80467	Screw (6-40 X 11/32)	3,6	85501	Code Bar	8
2669	Washer, Lock	1 to 11	80478	Post Spring	4	85502	Code Bar	8
2718	Plate, Retainer	1	80757	Screw, (10-32 X 1/2)	1	85504	Cam, Spreader	1
2802	Wrench (3/8-9/16 Open)	9	82565	Spring	6	85505	Cam, Right	1
3208	Lever, Clutch Throw-Out	4	83703	Screw, Hanger Mounting	1,2	85506	Cam, Left	1
3225	Sleeve	3	85379	Base	1,6	85508	Bearing	1,2
3287	Bushing	3	85380	Plate, Bottom Cover	8	85510	Arm, Roller-Right	1,2
3288	Washer	3	85381	Crank, Elevator Bell	2	85511	Arm, Roller-Left	1
3339	Nut (9/16-32 Hex.)	3	85382	Bushing	2	85517	Bearing, Bell Crank	1,2
3340	Washer, Lock	3	85383	Link Latching	2	85518	Rod, Fulcrum	1
3438	Washer	1,2	85384	Bushing	2	85519	Stop, Bell Crank	2
3595	Nut (1/4 - 32 Hex.)	6,7	85385	Link, Lever Bail	2	85520	Plate, Spring	1
3598	Nut (6-40 Hex.)	2,4,5,6,7,10,11	85386	Bushing	2	85521	Crank Bearing Bell	1,2
3599	Nut (4-40 Hex.)	6,7	85387	Screw (6-40 X 3/16)	2	85526	Plate, Mounting	2,7
3606	Nut (6-40 Hex.)	1,2,4,7	85389	Eccentric	2	85527	Lever, Shift	7
3640	Washer, Lock	6,7,10,11	85390	Bracket, Latch	4	85528	Lever, Yield	7
3845	Spring	3	85391	Plate, Clamp	4	85529	Screw (10-32 Shoulder)	7
4062	Washer	3	85392	Latch	4	85530	Latch, Shift	7
4702	Spring	5,7	85393	Bushing	4	85531	Stud, Shoulder	7
4838	Wrench (3/8 - 7/16 Open)	9	85397	Shim	1	85532	Crank, Shift Bell	2,7
4839	Wrench (1/2 X 7/16 Open End)	9	85400	Retainer	5	85533	Link, Shift	2
4840	Wrench (5/8 - 3/4 Open)	9	85401	Arm, Detent	5	85538	Bracket - Front	7
4841	Scale, 12 lb.	9	85402	Roller	5	85541	Shaft	6
5446	Screw (6-40 X 9/16)	3	85405	Housing, Detent	3	85542	Lever, "T" Transfer	6
6097	Spring	5,6	85406	Plunger, Detent	3	85543	Stud	6
6745	Screw (10-32 X 1/2)	3,1,8,10,11	85407	Spring	3	85544	Spacer	6
6746	Screw (6-40 X 5/16)	4,1,2,3,7	85408	Bearing	3	85549	Screw (1/4 - 32 Pilot)	6
6807	Screw (6-40 X 3/16)	6	85409	Shaft	3	85551	Ball, Selector Lever	7
6810	Screw (10-32 X 3/8)	1,2	85410	Handle	3	85552	Arm, Bail Roller	7
6811	Screw (6-40 X 5/8)	1,2,3,4,5,6	85411	Stop	3	85553	Shaft	7
6814	Screw (6-40 Pilot)	4,5	85412	Collar	3	85555	Shaft - Lower	7
7002	Washer	2,3,5,6,7,10,11	85413	Cam Reset	3	85556	Shaft - Upper	7
7150	Spacer	10,11	85414	Roller	3	85557	Lever, Selector	7
7824	Wick	3	85415	Bushing	3	85558	Lever, Selector	7
8185	Screw (1/4-20 X 3/4)	1,2	85416	Rail, Stop	1	85559	Washer, Spacer	7
8330	Washer	3	85421	Hanger	1,2	85560	Bushing	7
8491	Strip, Wearing	1,5	85423	Screw (5/16 - 18 Pilot)	1,2	85561	Nut (1/4 - 32 Guide)	7
8539	Screw (6-40 X 1/2)	2,5,6,7	85424	Plate, Side Cover	2	85563	Plate, End - Front	7
8543	Screw (6-40 X 1/4)	1,2,5	85426	Cover, Front-Upper	8	85564	Support, End Plate	5
9922	Oiler	3	85427	Cover, Front-Lower	8	85565	Bearing	5
26492	Spacer	3	85428	Reel, Tape	8	85566	Bearing	5
31636	Spring	10	85431	Bearing	4	85573	Bearing, Tape Reel	7
33038	Spring	6	85432	Latch	4	85574	Support	8
33828	Spring	2	85433	Shaft	4	85575	Bracket	8
34432	Washer	1,2,3,4,6,10,11	85434	Arm, Spring	4	85576	Pivot	8
36463	Spring	7	85435	Lever, Reset	4	85739	Pinion, 10 - T	3
41974	Spring	4	85437	Bushing	4	85816	Wick	2
49345	Spring	1,2	85438	Bearing	4	85820	Lever, Floating	2
49420	Spring	1,2,6	85439	Bail	4	85822	Roller	6,7
49653	Screw (10-32 X 13/16)	3	85440	Bail, Release	4	85823	Spacer	2
70388	Spring	7	85441	Shaft	3	85892	Plate	6
72089	Shim	5	85442	Driven Member	3	85893	Post	6
72137	Shim	5	85443	Driving Member	3	85894	Post, Spring	6
72139	Plate, Screw	5	85444	Gear	3	85895	Bar, Rail Shift Push	1
72468	Spring	5	85445	Cam, Tape Feed	3	85931	Post, Spring	2
72521	Wick	3	85446	Cam, Selector Lever Bail	3	86007	Detent	10
72764	Roller	4	85447	Cam, Transfer Lever	3	86283	Spring	7
72954	Guide, Tape	5	85448	Sleeve, Adjusting	3	86302	Spring	7
72973	Plate, Lid	5	85449	Rod, Fulcrum	1,2	86333	Screw (3/16 - 40 X 7/32)	1
72974	Lid, Retaining	5	85450	Nut (7/16 - 32 Hex.)	3	86339	Shim	3
73018	Cup, Oil	1	85451	Shaft	3	86571	Plate	1,6
			85452	Cam, Elevator	3	86572	Guide	7
			85453	Shaft, Pulley	1	86573	Bracket - Rear	6
			85454	Pulley	1	86574	Extension	6
			85455	Bearing	1	86575	Bearing, Ratchet	6
			85456	Post	2,4	86576	Pawl, Retaining	6
			85457	Gear, 34 - T	1	86577	Lever	6
			85458	Pinion, 5 - T	1			
			85459	Shaft	1			

ORIGINAL

NUMERICAL INDEX

Part Number	Part	Page	Part Number	Part	Page	Part Number	Part	Page
86580	.Lever, Tape Feed	6	91778	.Plate, Lock	11	125252	.Spring	4
86582	.Ratchet	6	91779	.Collar	10,11	125278	.Shaft	5
86585	.Shaft Ratchet	6	91780	.Spring	11	125696	.Post, Ball Spring	4
86586	.Bail, Push	6	91781	.Ball Operating	11	125757	.Wrench, 7/16 Socket	9
86587	.Plate, Clamp	6	91782	.Clutch	10	125763	.Wrench, 3/16 Open	9
86588	.Post, Stop	7,6	91783	.Clutch	10	125775	.Wrench, 3/8 - 7/16 Open	9
86589	.Hub, Timing	6	91784	.Cam	10	125776	.Wrench, 5/16 Open	9
86596	.Extension	6	91785	.Bracket	10,11	125858	.Pawl, Tape Feed	6
86597	.Bushing	6	91791	.Bracket	11	125861	.Roll, Feed	5
86598	.Arm, Stop	6	92598	.Wick, Bearing	2	125862	.Bearing, Feed Roll	5
86599	.Lever, Delay Selector	7,6	92897	.Cover	8	125867	.Bracket, Detent	5
86633	.Stud	7	93050	.Wick, Oil	4	125868	.Detent	5
86720	.Post, Spring	6	94042	.Screw, Pilot	8	125871	.Holder, Lid	5
86803	.Guide, Code Bar	1,2	98833	.Screw, Stop	7	125872	.Shaft	5
86804	.Guide, Link	5	101385	.Post, Spring	5	125873	.Latch	5
86806	.Plate, End - Rear	7,6	108809	.Screw(10 - 32 X 27/32)	1,6			
86807	.Screw (4-40 Pilot)	6	110434	.Screw(4 - 40 X 3/16)	5			
86808	.Bar, Frame	1,2	110435	.Nut (4 - 40 Hex.)	6			
86850	.Screw (10 - 32 X 1-1/4)	1,2	110437	.Spring	6			
87443	.Screw (10 - 32 X 15/16)	1,2	110440	.Dowel	5			
89064	.Arm, Transfer Ball	6	110442	.Screw Driver	9			
89065	.Bail Transfer	6	110443	.Scale, 8 oz.	9			
89066	.Sleeve	6	110444	.Scale, 10 oz.	9			
89078	.Holder, Spring	6	110743	.Washer, Lock	5			
89079	.Holder, Spring	6	112622	.Screw, Shoulder	6			
89096	.Wick Oil	1	112624	.Screw, (4 - 40 Shoulder)	5			
89896	.Oiler	4,3	112625	.Screw, (6 - 40 Shoulder)	4			
89897	.Nut, (10 - 32 Hex.)	4,3	112626	.Nut (10 - 32 Hex.)	1,2,7,8,6			
89954	.Wrench, 1/4 Socket	9						
89955	.Wrench, 5/16 Socket	9	112632	.Spring	5			
91122	.Extension	5	112635	.Spring	5			
91129	.Bail	5	112636	.Spring	6			
91617	.Shim	3	117781	.Kit, Gauge	9			
91771	.Escapement	10	121884	.Bracket, Backstop	4			
91772	.Lever, Operating	10,11	125011	.Washer	5,10,11			
91773	.Rod	11	125120	.Screw (6 - 40 Shoulder)	2,7			
91774	.Bail, Cam Follower	11	125180	.Screw (4 - 40 Shoulder)	6			
91775	.Shaft, Drive	10,11	125211	.Screw (10 - 32 X 3/4)	1,2			
91776	.Spring, Clutch	10	125236	.Spring	5			
91777	.Shaft	11	125251	.Spring	4,7			

LETYPESETTER
REG. U.S. PAT. OFF.

TELETYPESETTER

REG. U.S. PAT. OFF.